

لعبة دولار النينجا (Ninja Dollar) باستخدام الاردوينو

مقدمة

لعبة دولار النينجا عبارة عن لاعب يدعى دولار يحاول الهروب و القضاء على علامة المربع من أجل جمع أكبر قدر من النجوم التي تزيد من رصيده وتكون فرصة فوزه بالمسابقة أكبر، في هذا الدرس سنتعلم برمجة اللعبة باستخدام الاردوينو والشاشة الكرسطالية والأزرار ومصدر الصوت.

https://geeksvally.com/wp-content/uploads/2022/03/IMG_2154.mp4

المواد والأدوات

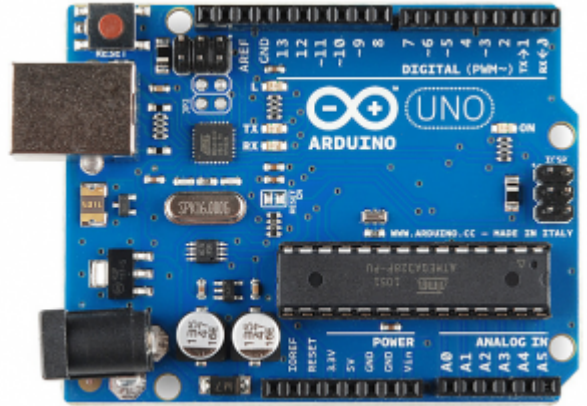

1 × اردوينو أونو



×1 سلك الوردينو



×1 شاشة كرسالية

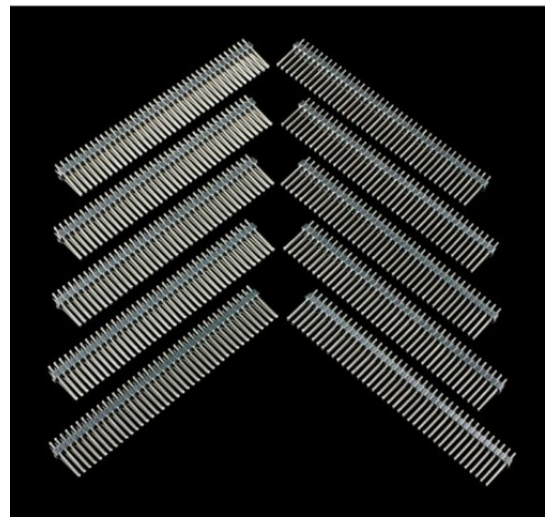

×1 رأس دبوس 40



حزمة أسلاك توصيل (ذكر - ذكر)

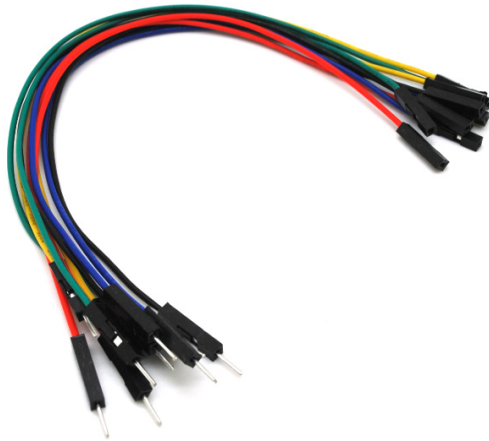

حزمة أسلاك توصيل (ذكر - أنثى)

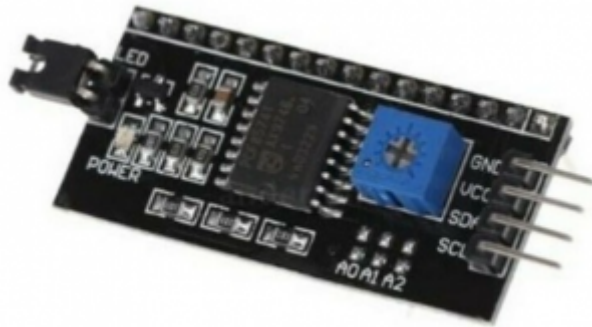

2C / IIC Serial Interface Module x1



×2 ضغط تحكم

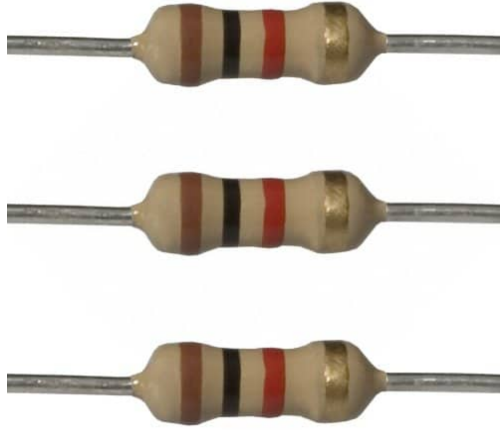

×2 مقاومة $1K\Omega$

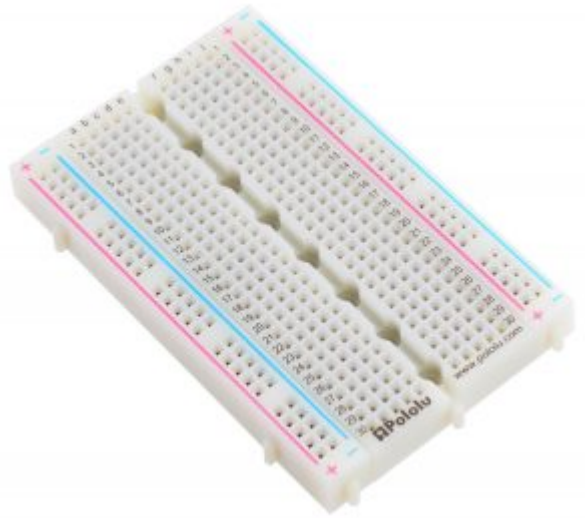

×1 لوحة تجارب - حجم كبير



×1 مصدر صوت

توصيل الدائرة

لمعرفة المزيد حول الشاشة الكرسطالية يمكنك الرجوع للدرس التحكم بالشاشة الكرسطالية LCD.

لا بد من تلحيم المنافذ مع الشاشة الكرسطالية، للمزيد حول اللحام يمكنك الرجوع للدرس تعلم كيفية التلحيم – تلحيم القطع باللوحة الإلكترونية

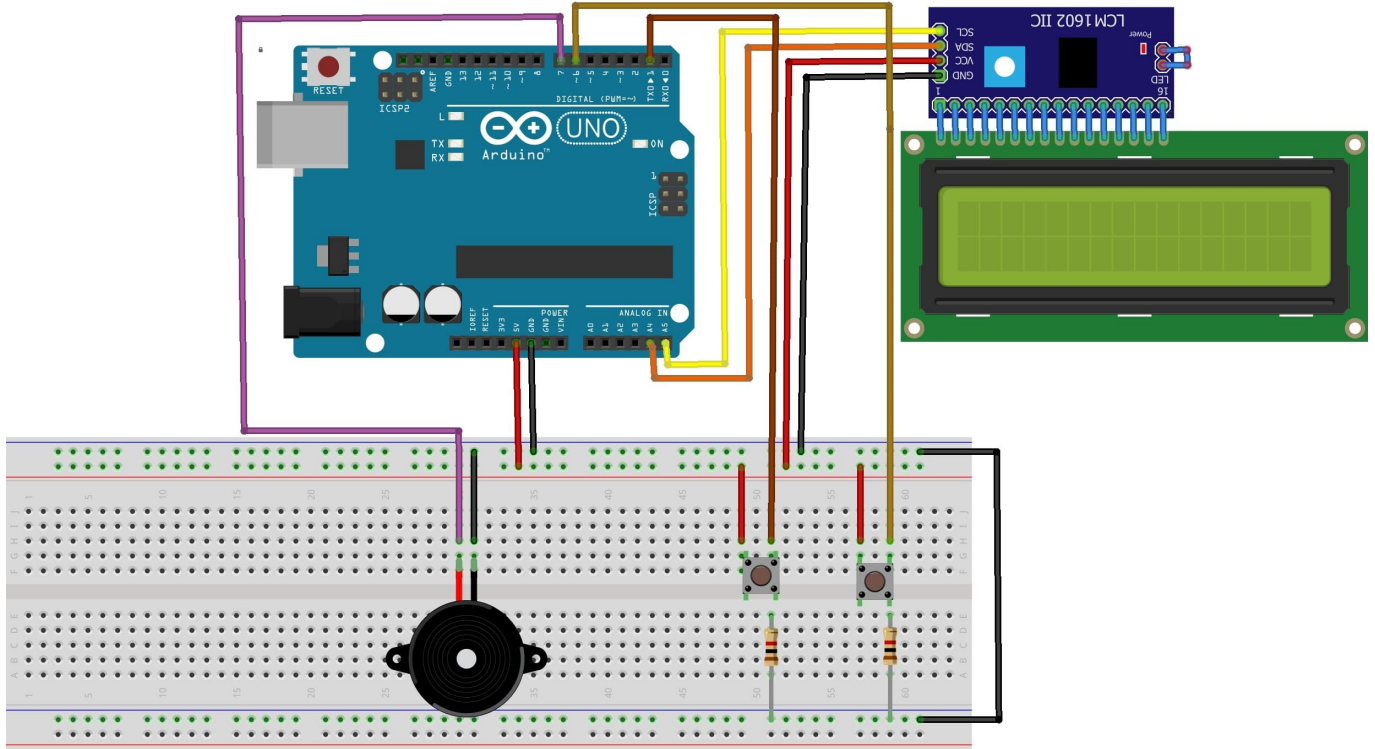

البرمجة

ارفع الكود البرمجي للعبة دولار النينجا على لوحة الاردوينو باستخدام برنامج اردوينو IDE.

```
#include <LiquidCrystal_I2C.h>
LiquidCrystal_I2C lcd(0x27, 16, 2);
const int buttonPin1=1;
const int buttonPin2=6;
const int buzzer=7;
unsigned long pts=0;
//set buttonstates
bool buttonState1=0;
bool buttonState2=0;
//random number for position of obstacles
int randomNums[6];
//random number for number of obstacles
int randomNum=0;
//random number for position of pts
int randomNums1[3];
//random number for number of pts
int randomNum1=0;
//start delay time, which decreases gradually
unsigned int myDelay=500;
```

```

//made this boolean to check if button2 is pressed because if it's pressed once in
the first for loop i want obstacles not to be written until the end of it
bool temp=0;
//this variable stores the positions of the warrior while he shoots. there can be 16
positions because the warrior has 16 positions.
int tempI[16];
//i use this boolean to check if the point is caught
bool temp1=0;

//use this variable to store the position of the caught point. it must be and array
to store the position of all the points in one iteration of the first for loop. if
it stored just one position, then the "old" point would come back in the new
iteration
int tempI1[3];
//use this variable to have a number of shots of the warrior, which is also the
length of an array tempI
int button2IsPressed=0;

void setup() {
  // set up the LCD's number of columns and rows:
  lcd.begin();
  // set buttonpin mode
  pinMode(buttonPin1,INPUT);
  pinMode(buttonPin2,INPUT);
  pinMode(buzzer,OUTPUT);
  lcd.setCursor(4,0);
  lcd.print("THE GAME");
  lcd.setCursor(2,1);
  lcd.print("STARTS IN ");
  lcd.print("5");
  delay(1000);
  lcd.setCursor(12,1);
  lcd.print("4");
  delay(1000);
  lcd.setCursor(12,1);
  lcd.print("3");
  delay(1000);
  lcd.setCursor(12,1);
  lcd.print("2");
  delay(1000);
  lcd.setCursor(12,1);
  lcd.print("1");
  delay(1000);
  lcd.clear();
}

void loop() {
  here:

  randomNum=random(5);
  for(int i=0; i<randomNum; ++i){

```

```

randomNums[i]=random(16);}
  randomNum1=random(3);
for(int i=0; i<randomNum1; ++i){
  randomNums1[i]=random(16);
}
//i reset temp variable before every new for loop because the cycle of the moving
warrior starts again
temp=0;
for(int j=0; j<3; ++j){
  tempI1[j]=0;
}
  button2IsPressed=0;
//loop that writes dollar(warrior) on the lcd which jumps everytime button is
pressed
  for(int i=0; i<16; ++i){
    //pts must be written here because of the lcd.clear() below (pts wouldn't
be written down the whole time otherwise)
    //i must check if pts is greater than 9 or 99 etc to know how many gaps i
should leave for the number. the more points are collected, the smaller delay time
is and the faster is dollar
    if(pts>9 && pts<20)
    {lcd.setCursor(14,0);
    myDelay=400;
    }
    else if(pts>19 && pts<30) {
    lcd.setCursor(14,0);
    myDelay=300;
    }
    else if(pts>29 && pts<50)
    {
    myDelay=200;
    lcd.setCursor(14,0);
    }
    else if(pts>=50){
    pts=0;
    myDelay=500;
    lcd.clear();
    lcd.setCursor(5,0);
    lcd.print("VICTORY");
    tone(buzzer,262);
    delay(200);
    tone(buzzer,330);
    delay(200);
    tone(buzzer,392);
    delay(100);
    tone(buzzer,330);
    delay(100);
    tone(buzzer,392);
    delay(100);
    tone(buzzer,523);
    delay(200);
    noTone(buzzer);
    delay(3000);

```

```

        lcd.clear();
        goto here;
    }
    else lcd.setCursor(15,0);
    lcd.print(pts);
    buttonState1=digitalRead(buttonPin1);
    buttonState2=digitalRead(buttonPin2);
//setting obstacles if the warrior didn't shoot or he shot but he also jumped
if(!temp){
    for(int j=0; j<randomNum; ++j){
        lcd.setCursor(randomNums[j],1);
        lcd.print("#");
    }
}
//checking if the warrior had shot but there were obstacles before him, we want
those obstacles to stay
else{
    for(int j=0; j<randomNum; ++j){
        //i check only the tempI[0] position because that's the when the warrior shot for
the first time and he removed all the remaining obstacles
        if(tempI[0]>randomNums[j]){
            lcd.setCursor(randomNums[j],1);
            lcd.print("#");
        }
    }
}

//setting pts
if(!temp1){
    for(int j=0; j<randomNum1; ++j){
        lcd.setCursor(randomNums1[j],0);
        lcd.print("*");
    }
}
else{
    for(int j=0; j<randomNum1; ++j){
        if(randomNums1[j]!=tempI1[j]){
            lcd.setCursor(randomNums1[j],0);
            lcd.print("*");
        }
    }
}

//if the button is pressed we set the cursor up (so that our warrior
jumps)
if(buttonState1==HIGH)
{lcd.setCursor(i,0);
tone(buzzer,131);
delay(200);
noTone(buzzer);
}
else lcd.setCursor(i,1);
lcd.print("$");

```



```

        //if button2 is pressed our warrior shoots. i had to put this loop here so
that warrior shoots from his current spot and then continues to move. that's why
delay time is 5 so that this loop finishes as soon as possible
        if (buttonState2==HIGH)
        {
            tone(buzzer,175);
            delay(100);
            noTone(buzzer);
            temp=1;
            //if the button1 is low then we remove all the obstacles. that's why the
state if temp variable is changed
            if(buttonState1==LOW)
            {
                tempI[button2IsPressed]=i;
            }
            ++button2IsPressed;
            for(int k=i+1; k<16; ++k){
                //if the buton1 is low then warrior shoots in the second row. otherwise it
shoots in the first row
                if(buttonState1==LOW)
                lcd.setCursor(k,1);
                else lcd.setCursor(k,0);
                lcd.print("~");
                delay(5);
                if(buttonState1==LOW)
                lcd.setCursor(k-1,1);
                else lcd.setCursor(k-1,0);
                lcd.print(" ");
                delay(5);
            }
        }
        delay(myDelay);
        lcd.clear();
        //checking if the positions of the pts and the warrior are the same and
if the button is pressed because then they collide and we gain 5 extra points
        for(int j=0; j<randomNum1; ++j){
            if(i==randomNums1[j] && buttonState1==HIGH){
                temp1=1;
                tempI1[j]=i;
                pts+=5;
            }
        }
        //checking if the positions of the obstacle and the warrior are the same
and if the button1 is not pressed, then they collide and it is the end of the game
        for(int j=0; j<randomNum; ++j){
            if(i==randomNums[j] && buttonState1==LOW && temp==0) {
                pts=0;
                myDelay=500;
                lcd.clear();
                lcd.setCursor(6,0);
                lcd.print("GAME");
                lcd.setCursor(6,1);
                lcd.print("OVER");
            }
        }

```

```

tone(buzzer,349);
delay(200);
tone(buzzer, 277);
delay(200);
tone(buzzer,220);
delay(100);
tone(buzzer,277);
delay(100);
tone(buzzer,220);
delay(200);
noTone(buzzer);
delay(3000);
lcd.clear();
//i must skip the for loop because otherwise the game would continue where
it ended
    goto here;
}
//counting number of skipped obstacles and that would be our points
else if(i==randomNums[j] && buttonState1==HIGH) ++pts;
}
}
}

```

شرح الكود البرمجي

سنقوم في البداية باستدعاء مكتبة (LiquidCrystal_I2C.h) الخاصة بوحدة i2c والتي تحتوي على مجموعة أوامر برمجية نحتاجها في المشروع.

```
#include <LiquidCrystal_I2C.h>
```

نعرف عنوان وحدة i2c.

```
LiquidCrystal_I2C lcd(0x27, 16, 2);
```

نعرف المتغيرات الخاصة بالأزرار buttonPin1 تم ربطه بالمنفذ 1 و buttonPin2 تم ربطه بالمنفذ 6 ومصدر الصوت buzzer تم ربطه بالمنفذ 7.

```
const int buttonPin1=1;
const int buttonPin2=6;
const int buzzer=7;
```

ستكون الحالة الابتدائية لكل الأزرار =0.

```
bool buttonState1=0;
bool buttonState2=0;
```

سيتم اختيار أماكن عشوائية لعلامة المربع على الشاشة الكرسطالية.

```
//random number for position of obstacles
int randomNums[6];
//random number for number of obstacles
int randomNum=0;
```

وأماكن عشوائية لعلامة النجمة على الشاشة الكرسطالية.

```
//random number for position of pts
int randomNums1[3];
//random number for number of pts
int randomNum1=0;
```

في الدالة setup() ستستقبل الأزرار المدخلات والشاشة ومصدر الصوت للمخرجات.

ستحتوي الشاشة الابتدائية للعبة دولار نينجا على كلمة THE GAME ثم سيبدأ العدر التنازلي من 5 إلى 1 بعد ذلك ستبدأ اللعبة مباشرة.

```
void setup()
{
  // set up the LCD's number of columns and rows:
  lcd.begin();
  // set buttonpin mode
  pinMode(buttonPin1,INPUT);
  pinMode(buttonPin2,INPUT);
  pinMode(buzzer,OUTPUT);
  lcd.setCursor(4,0);
  lcd.print("THE GAME");
  lcd.setCursor(2,1);
  lcd.print("STARTS IN ");
  lcd.print("5");
  delay(1000);
  lcd.setCursor(12,1);
  lcd.print("4");
  delay(1000);
  lcd.setCursor(12,1);
  lcd.print("3");
  delay(1000);
  lcd.setCursor(12,1);
  lcd.print("2");
  delay(1000);
  lcd.setCursor(12,1);
  lcd.print("1");
  delay(1000);
  lcd.clear();
}
```

في الدالة loop() ستبدأ النجوم وعلامة المربع بالظهور بأماكن عشوائية متفرقة.

وسيحاول اللاعب دولار القضاء على علامات المربع التي تعيق طريقه وذلك بالضغط المطول على الزر الأيمن في لوحة التجارب

ويحاول أيضاً التقاط النجوم التي تزيد من رصيده وتزيد من فرصة فوزه وذلك بالاتجاه نحوها إما للأسفل أول للأعلى بالضغط المطول على الزر الأيسر في لوحة التجارب.

إذا لم يستطع الهروب وحدث تلامس بينه وبين علامة المربع ستنتهي اللعبة بخسارة اللاعب دولار وستظهر رسالة The game over.

```
void loop()
{
  here:

  randomNum=random(5);
  for(int i=0; i<randomNum; ++i){
    randomNums[i]=random(16);}
    randomNum1=random(3);
  for(int i=0; i<randomNum1; ++i){
    randomNums1[i]=random(16);
  }
  //i reset temp variable before every new for loop because the cycle of the moving
  warrior starts again
  temp=0;
  for(int j=0; j<3; ++j){
    tempI1[j]=0;
  }
  button2IsPressed=0;
  //loop that writes dollar(warrior) on the lcd which jumps everytime button is
  pressed
  for(int i=0; i<16; ++i){
    //pts must be written here because of the lcd.clear() below (pts wouldn't
    be written down the whole time otherwise)
    //i must check if pts is greater than 9 or 99 etc to know how many gaps i
    should leave for the number. the more points are collected, the smaller delay time
    is and the faster is dollar
    if(pts>9 && pts<20)
    {lcd.setCursor(14,0);
    myDelay=400;
    }
    else if(pts>19 && pts<30) {
    lcd.setCursor(14,0);
    myDelay=300;
    }
    else if(pts>29 && pts<50)
    {
    myDelay=200;
    lcd.setCursor(14,0);
    }
    else if(pts>=50){
    pts=0;
    myDelay=500;
    lcd.clear();
    lcd.setCursor(5,0);
    lcd.print("VICTORY");
    tone(buzzer,262);
    delay(200);
```

```

        tone(buzzer,330);
        delay(200);
        tone(buzzer,392);
        delay(100);
        tone(buzzer,330);
        delay(100);
        tone(buzzer,392);
        delay(100);
        tone(buzzer,523);
        delay(200);
        noTone(buzzer);
        delay(3000);
        lcd.clear();
        goto here;
    }
    else lcd.setCursor(15,0);
    lcd.print(pts);
    buttonState1=digitalRead(buttonPin1);
    buttonState2=digitalRead(buttonPin2);
//setting obstacles if the warrior didn't shoot or he shot but he also jumped
if(!temp){
    for(int j=0; j<randomNum; ++j){
        lcd.setCursor(randomNums[j],1);
        lcd.print("#");
    }
}
//checking if the warrior had shot but there were obstacles before him, we want
those obstacles to stay
else{
    for(int j=0; j<randomNum; ++j){
        //i check only the tempI[0] position because that's the when the warrior shot for
the first time and he removed all the remaining obstacles
        if(tempI[0]>randomNums[j]){
            lcd.setCursor(randomNums[j],1);
            lcd.print("#");
        }
    }
}

//setting pts
if(!temp1){
    for(int j=0; j<randomNum1; ++j){
        lcd.setCursor(randomNums1[j],0);
        lcd.print("*");
    }
}
else{
    for(int j=0; j<randomNum1; ++j){
        if(randomNums1[j]!=tempI1[j]){
            lcd.setCursor(randomNums1[j],0);
            lcd.print("*");
        }
    }
}

```

```

}
}
//if the button is pressed we set the cursor up (so that our warrior
jumps)
if(buttonState1==HIGH)
{lcd.setCursor(i,0);
tone(buzzer,131);
delay(200);
noTone(buzzer);
}
else lcd.setCursor(i,1);
lcd.print("$");
//if button2 is pressed our warrior shoots. i had to put this loop here so
that warrior shoots from his current spot and then continues to move. that's why
delay time is 5 so that this loop finishes as soon as possible
if (buttonState2==HIGH)
{
tone(buzzer,175);
delay(100);
noTone(buzzer);
temp=1;
//if the button1 is low then we remove all the obstacles. that's why the
state if temp variable is changed
if(buttonState1==LOW)
{
tempI[button2IsPressed]=i;
}
++button2IsPressed;
for(int k=i+1; k<16; ++k){
//if the buton1 is low then warrior shoots in the second row. otherwise it
shoots in the first row
if(buttonState1==LOW)
lcd.setCursor(k,1);
else lcd.setCursor(k,0);
lcd.print("~");
delay(5);
if(buttonState1==LOW)
lcd.setCursor(k-1,1);
else lcd.setCursor(k-1,0);
lcd.print(" ");
delay(5);
}
}
delay(myDelay);
lcd.clear();
//checking if the positions of the pts and the warrior are the same and
if the button is pressed because then they collide and we gain 5 extra points
for(int j=0; j<randomNum1; ++j){
if(i==randomNums1[j] && buttonState1==HIGH){
temp1=1;
tempI1[j]=i;
pts+=5;
}
}

```

```

    }
    //checking if the positions of the obstacle and the warrior are the same
and if the button1 is not pressed, then they collide and it is the end of the game
    for(int j=0; j<randomNum; ++j){
    if(i==randomNums[j] && buttonState1==LOW && temp==0) {
    pts=0;
    myDelay=500;
    lcd.clear();
    lcd.setCursor(6,0);
    lcd.print("GAME");
    lcd.setCursor(6,1);
    lcd.print("OVER");
    tone(buzzer,349);
    delay(200);
    tone(buzzer, 277);
    delay(200);
    tone(buzzer,220);
    delay(100);
    tone(buzzer,277);
    delay(100);
    tone(buzzer,220);
    delay(200);
    noTone(buzzer);
    delay(3000);
    lcd.clear();
    //i must skip the for loop because otherwise the game would continue where
it ended
    goto here;
    }
    //counting number of skipped obstacles and that would be our points
    else if(i==randomNums[j] && buttonState1==HIGH) ++pts;
    }
}
}

```

بعد اكتمال عملية الرفع يمكنك بدء جو المتعة والتحدي مع دولار النينجا.

أختبر صحة خطواتك.

لا تنسَ فصل مصدر الطاقة بعد الانتهاء من استخدام النظام.