

جهاز تنفس صناعي (Breath team).

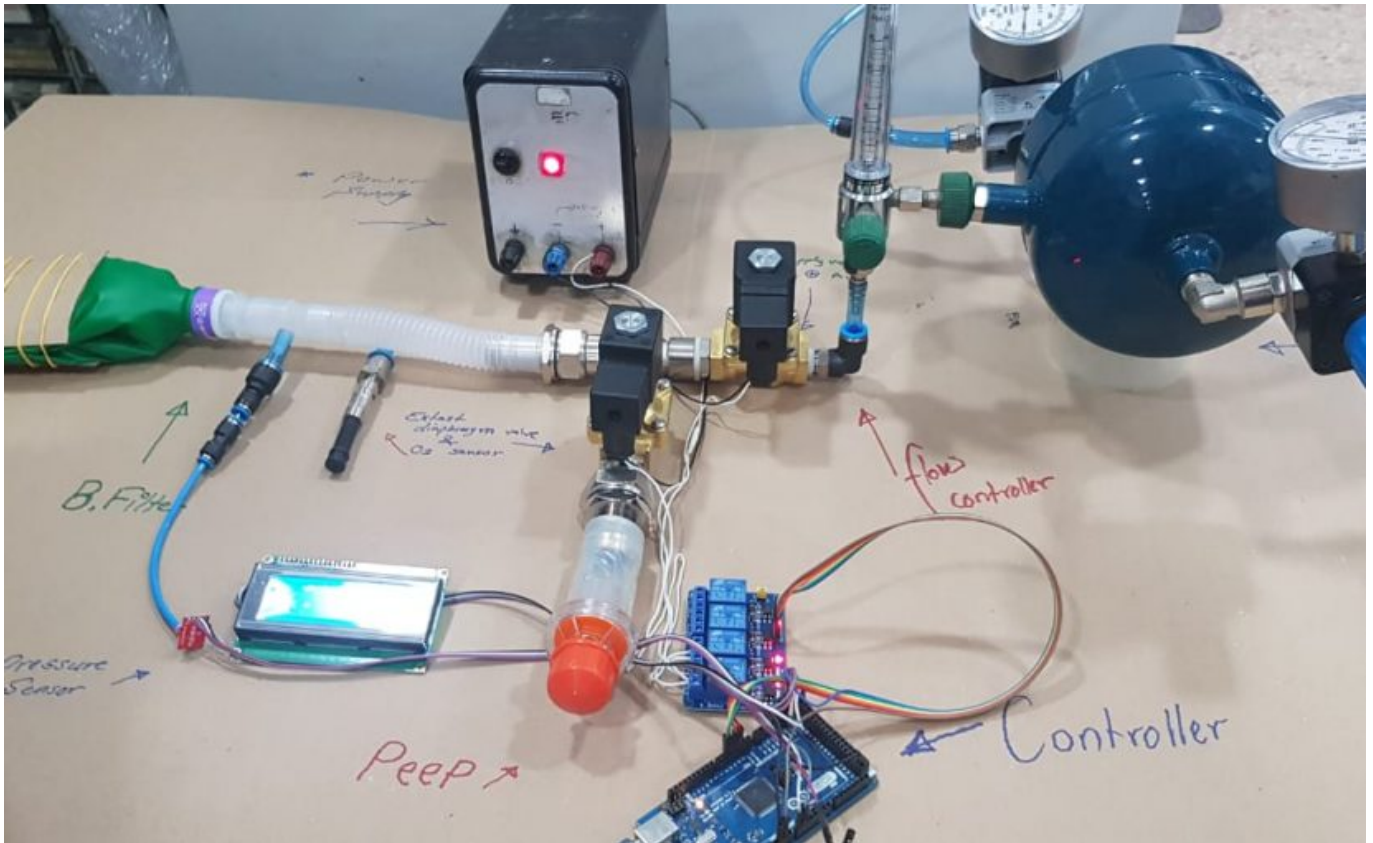

Overview

The globe is facing epidemic started during December 2010. Increasing reported numbers with COVID-19 Virus. More than two million patients worldwide with mortality rate of 1-3% This study was done to take part in helping patients and authorities by designing and building a ventilator with off-the-shelf parts Idea:

- Breath is an initiative led by local talents. After touching COVID 19 effect and benchmarking the lack of ventilators countries with higher infection rate.
- We decided to design and build a simple open source ventilator that will help local authorities in fighting COVID.
- Ventilators are available product in the market, but due to the increased number of patients, lack of supply appeared. So, we joined forces with hundreds on initiatives in the world to build local ventilators

- We started by gathering experts in Engineering, Medical Field, Start ups and Design.

Bill of materials

Here

Ventilator

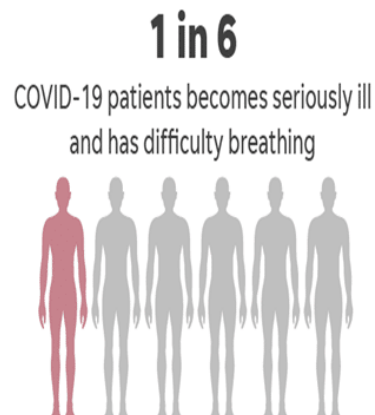

In the coronavirus pandemic, ventilators, the medical devices that help patients breathe, are highly sought after and hard to find - but they are not always successful.

One in six COVID-19 patients becomes seriously ill and has difficulty breathing, according to the World Health Organization. That's because lungs are the main battleground in COVID-19 infections, which can cripple breathing functions.

The Intensive Care National Audit and Research Centre in the U.K. reported that 66% of patients on ventilators died. A University of Washington medical study published March 30 noted that nine of 18 patients died.

Infected patients can develop acute respiratory distress syndrome - ARDS - a condition with a high mortality rate. Those with ARDS build up fluids in the alveoli, the tiny air sacs in the lungs that transfer oxygen to the blood and remove carbon dioxide

Presentation Here

Main Pain

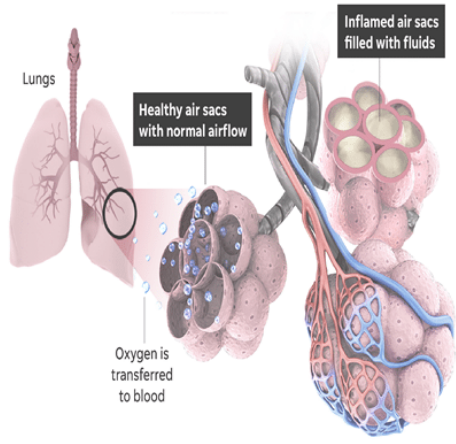

More than 40 percent of COVID-19 patients develop ARDS, according to a March 13 study from the Journal of the American Medical Association. Other serious respiratory ailments can also occur

As the transfer process is impaired and oxygen levels fall, ventilators keep patients breathing. While they don't treat the disease, they do give patients time to fight it.

Bridge between life and death: Most COVID-19 patients on ventilators will not survive.

But coronavirus patients need more time - an average of 10 days, according to the University of Washington study. Other reports say one to two weeks is usual. A typical ICU patient averages 3-7 days, according to the National Centre for Biotechnology Information.

The devices are removed once patients can breathe on their own.

Ventilators range in size and can cost \$25,000 to \$50,000 or more. They are used in intensive care units.

Our Solution

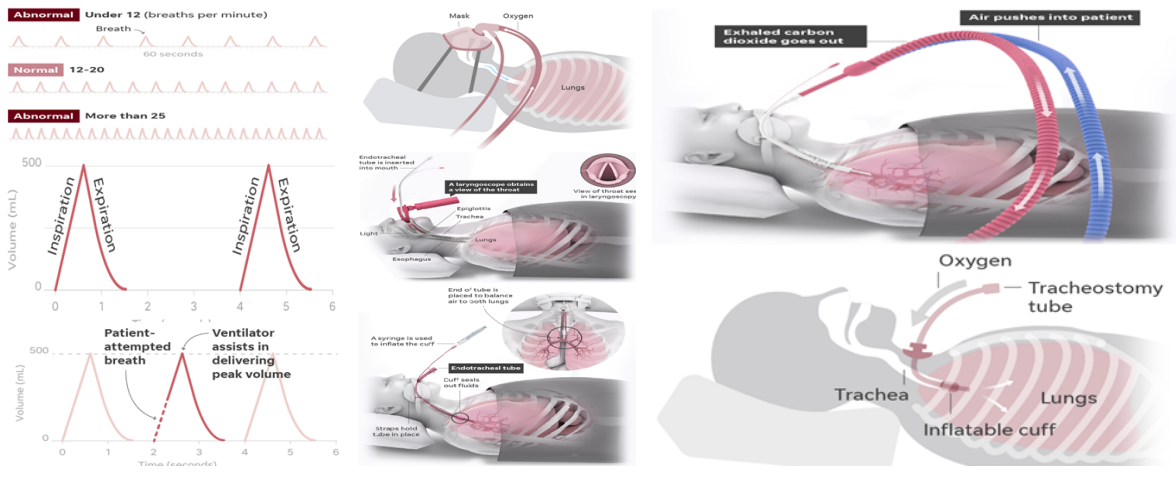

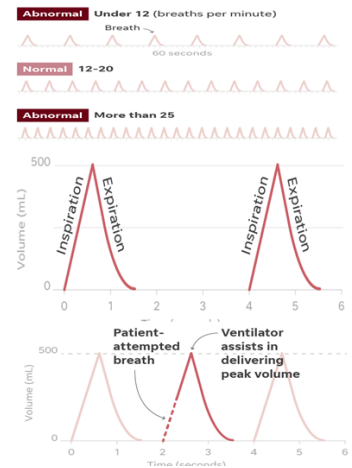
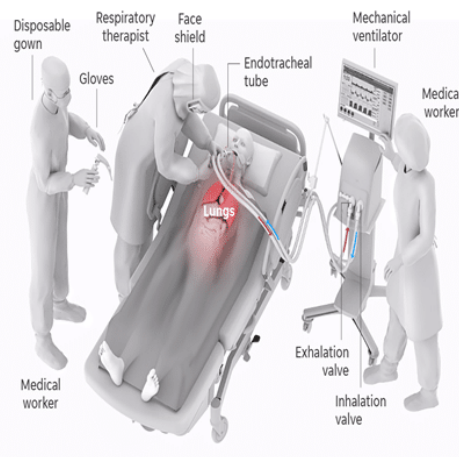

- With lack of Ventilators vs the numbers of the victims of COVID 19 and the high cost of it. so we need to build a low cost Ventilators to support our countries in the middle east.
- Ventilators gently pump air through a breathing tube into the patient's lungs and allow the patient to exhale. This gives patients oxygen and removes carbon dioxide, which can damage the patient's organs if not expelled. In some cases, air with higher oxygen content is used. Settings are tailored to patient needs.
- Patients can't talk because the tube passes through their vocal cords. The tubes can be uncomfortable and it takes time to get used to them, according to AgingCare.
- Ventilator operation is closely monitored to maintain pressure and expiration levels.
- Doctors monitor patient breathing rates per minute.
A popular mode used with ventilators is called assist-control (AC). In that mode, the ventilator assists with breathing. It's ideal for recovery because the patient only has to initiate a breath and the ventilator does the rest.
In this example, the respiratory rate is set to 15 breaths per minute. That means the patient will receive a breath every four seconds, regardless if the patient needs a breath. Even if the patient attempts a breath in between the timed breaths, the ventilator will take over and deliver the same volume of air as the timed breath.
- Patients are connected to ventilators in three ways. Though patients are sedated for the invasive procedures, the process of putting tubes in patients can be dangerous for health care workers, who risk being infected themselves. There's also a risk of infection for patients with breathing tubes.

1. **Non-invasive mask:**

In less critical cases, oxygen can be delivered through a face mask instead of a tube. This type of ventilator can be more commonly available in some areas and is relatively safe to deploy.

2. **Endotracheal tube:**

For more invasive procedures, medical workers don protective clothing and sanitize and sterilize the ventilator equipment.

A specialist called a respiratory therapist inserts a laryngoscope into the patient's mouth and guides the endotracheal tube into the windpipe.

Once the tube is inserted, a cuff is inflated to keep the tube in place and seal out secretions.

The laryngoscope is removed and the tube is taped to the side of the face. The tube is checked to make sure it can equally inflate both lungs.

The endotracheal tube is attached to the lines running to the mechanical ventilator.

Endotracheal tube

The endotracheal tube is attached to the lines running to the mechanical ventilator

3. **Tracheotomy:**

This is a more invasive procedure with an incision in the windpipe for insertion of a tracheal tube. This method is less likely to be used for COVID-19 patients since it puts the health care team at increased risk from aerosolized viral particles which can remain infectious for up to three hours.

User interface

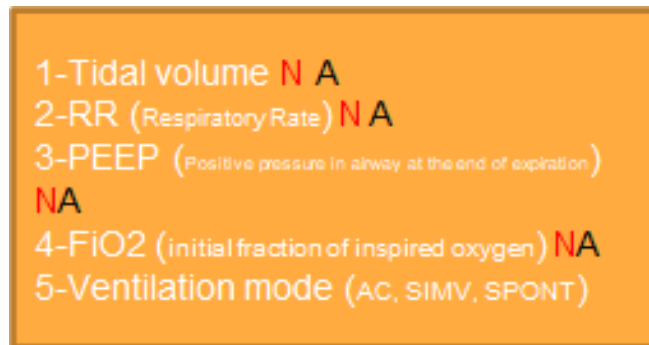

Name	Description
Oxygen percentage	This is the quantity of oxygen the control lets flow inside the tank when the air and oxygen mixture is made
Breathing frequency	It is the frequency at which the user breaths, in breathing times per minute
Tank Low/High Limit Pressure	Defines the range of pressure in the tank. If the pressure is lower than the limit, the compressor turns on to refill the tank to the pressure .required
Lungs Low/High Limit Pressure	Defines the range of pressure in the lungs. If the pressure is lower than the limit, the inspiration valve turns on after each period passes. Helps .to control the air flow and pressure
Operational Mode	Selects the operational mode the ventilator will use. There are three modes of operation: pressure, time, and interactive mode
Alarm Time	.Defines how much time the alarm is going to ring when required
Inspiration/Expiration percentage time	Sets the percentage of time that an inspiration and expiration takes of .the breathing period defined previously
Pressure Units	Defines the pressure units that are going to be used to interact in the .user interface on the LCD
Temperature Units	Defines the temperature units that are going to be used to interact in .the user interface on the LCD

Flow Chart

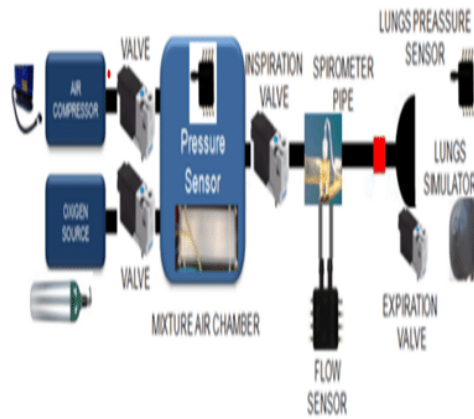

The Machine consists of

1. Regulators
2. Solenoid Valves
3. Spirometer
4. Flow Sensor
5. Lung Pressure meter
6. Pressure controller
7. Volume controller

Controller

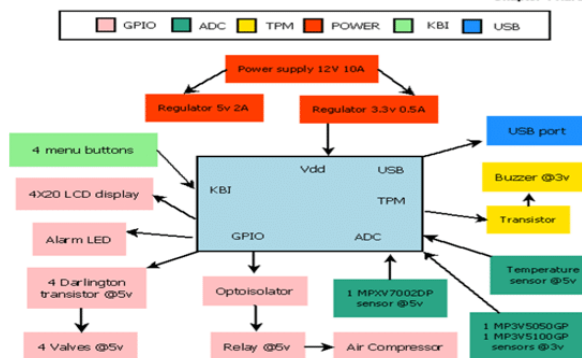

We used the Arduino Microcontroller with the following blocks

- Pneumotachometer: measures the lung volume by transducing pressure to voltage
- Spirometer: measures static pulmonary volume which indicates
- Tidal volume: Amount of gas inspired or expired at each breath
- Inspiratory reserve volume: Maximum amount of additional air that can be inspired at the end of a normal inspiration
- Expiratory reserve volume: Maximum amount of additional air that can be expired at the end of a normal expiration
- Residual volume: The volume of air remaining in the lungs after a maximum expiration
- Flow measurement: During inspiration the gas flows from the ventilator to the patient, A measure that total pressure, B measures the static pressure, the difference is the dynamic pressure which proportional to the velocity of gas flow. During expiration the process is

- reversed. C measures CO₂, O₂
- Breathing Controller
- Alarm system: The alarm indicates different patient parameter such as exhaled volume or airway pressure, also the ventilation system shall detect whether a breath has been taken or not. Measuring changes in aspiratory flow and pressure by using sensors. If no inspiration was detected for a certain time an alarm will be triggered.
- Human interface

Assemblies guide (slide 30) [Click here](#)

Breathing Control

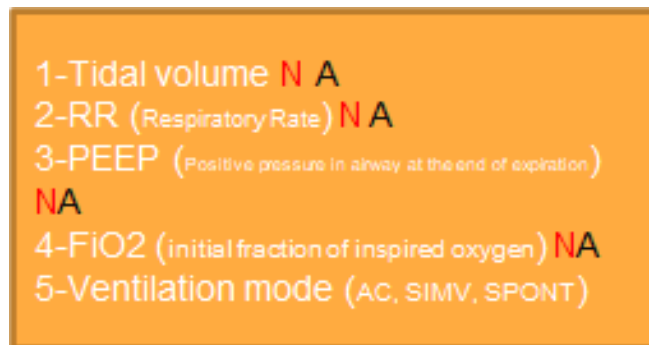

Ventilator Type	Description
Volume- Cycles	Inspiration of gas stops when a designated pressure is achieved
Volume- Cycles	Inspiration ends when the desired volume of gas has been introduced
Time- Cycles	Inspiration and expiration are programmed the same as the gas flux
Flux- Cycles	Inspiration ends when the aspiratory flux is below a pre-determined level
Mixed	The most commonly used, combines the attributes of the other classifications

Dashboard

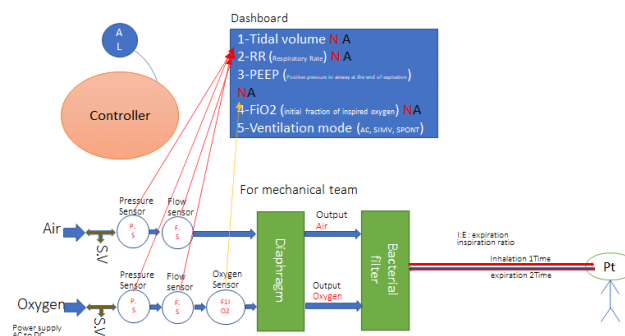

Our system in a nutshell will be mechanical as the graph on the right

The main points any physician was included in our survey in any ventilator were

1. Tidal Volume
2. Respiratory Rate
3. PEEP
4. Oxygen Percentage
5. Ventilation mode

Career Block Diagram (slide 31) [Click here](#)

Alarm System

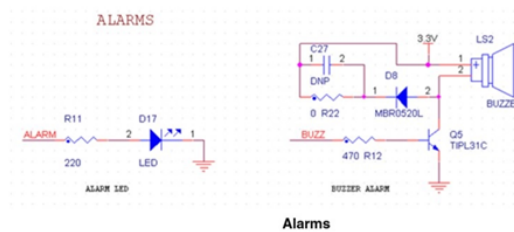

Alarm system

The alarm indicates different patient parameter such as exhaled volume or airway pressure, also the ventilation system shall detect whether a breath has been taken or not. Measuring changes in aspiratory flow and pressure by using sensors. If no inspiration was detected for a certain time an alarm will be triggered.

Mechanical Parts

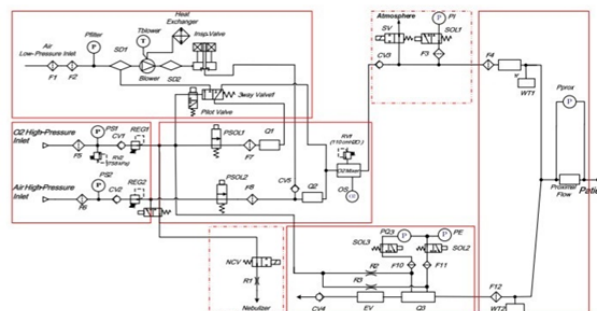

Part[

Quantity

Electrical valve connectors	1
Pressure valve	5
Airway pressure valve	3
Reduction	many
TACHOMETER	
Solenoid Valve	4
Diagram Valve	1
Bacterial Filter	1
Safety Valve	3

Electrical Diagrams

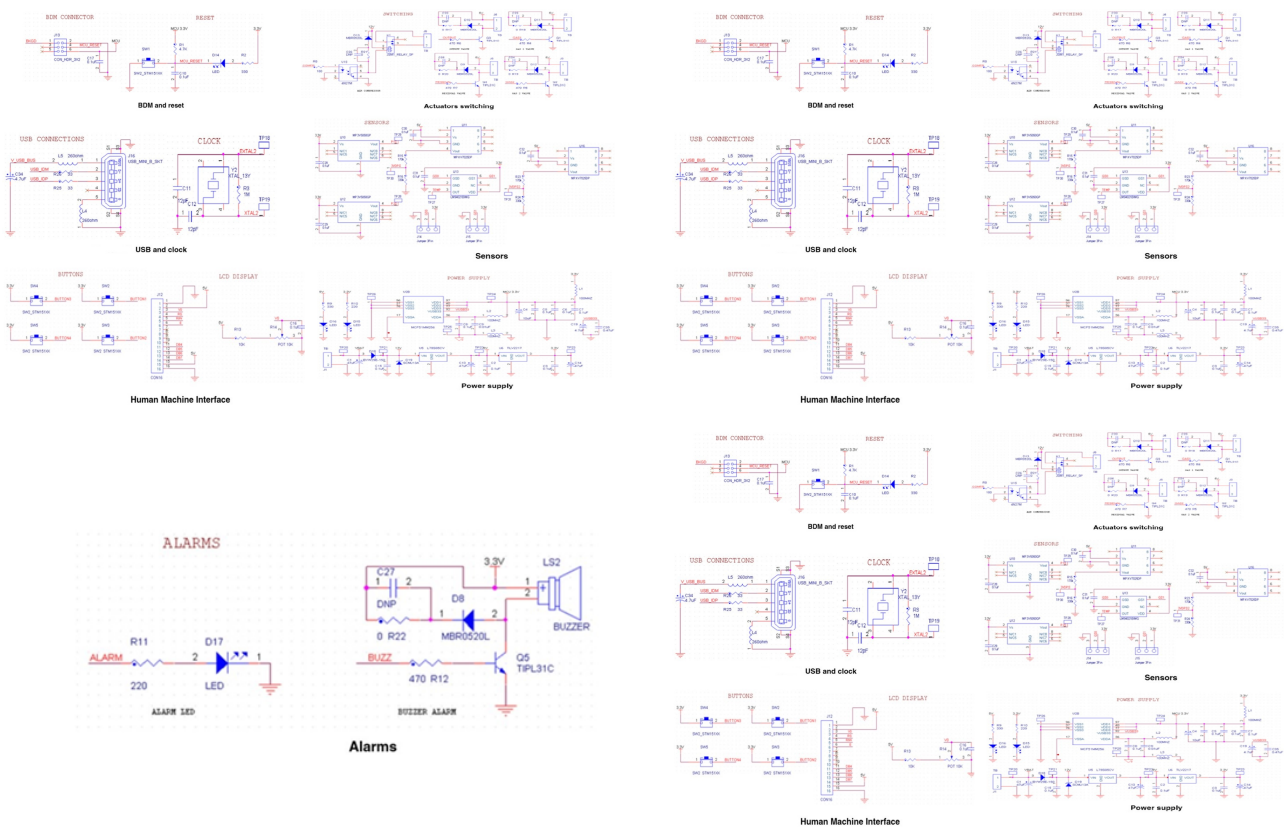

Can be used as methods for testing and examination

Electrical circuits (Slide 32-38) [click Here](#)

Program

[Click Here](#)

Value Proposition



One in six COVID-19 patients becomes seriously ill and has difficulty breathing, according to the World Health Organization. That's because lungs are the main battleground in COVID-19 infections, which can .cripple breathing functions

case in UAE and KSA alone, so 3,501 are in need of a Ventilator and the numbers are rising 21,010

- Secure:
Reliable mechanical structure: The open ventilator uses certified and tested parts, taking into account fatigue tests to avoid the risk of collapse or putting the patient at risk
- Scalable:
Decentralization of the procedure for scaling The Open Ventilator materials are homogeneous, offering the same quality without variations in mechanical resistance, in addition to speeding up production
- Functional:
It meets the medical requirements.
From the beginning, the team included a group of doctors, scientists and engineers, which allowed them to achieve the health certification in record time.

Action Plan

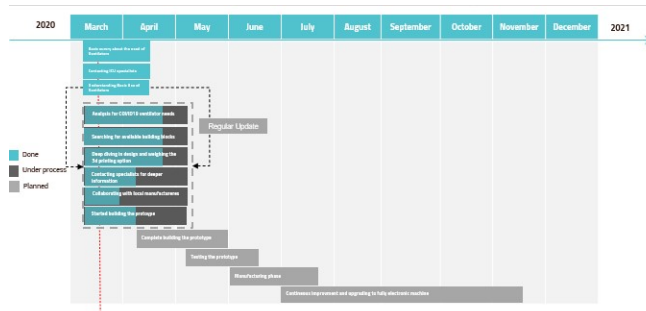

Our Action Plan to go to market as the graph shows

Business Canvas

Key Partners Governments, all the first couple of years it will be B2G. Also we will be marketing to private hospitals	Key Activities It will be a low-cost highly effective local Ventilator and the customer support will be by the application specialist	Value Proposition One in six COVID-19 patients becomes seriously ill and has difficulty breathing, according to the World Health Organization. That's because lungs are the main battleground in COVID-19 infections, which can cripple breathing functions. 21,010 case in UAE and KSA worse, so 3,501 are in need of a Ventilator and the numbers are rising	Customer Relationships Continuous follow up, training, and weekly to monthly visits	Customer Segments Private and Public hospitals
	Key Resources For swift process we will outsource the manufacturing for a local factory and minimize the cost.		Channels Via direct sales, online sales and distributors	
Cost Structure Manufacturing cost \$2,000 Cost of R&D and testing \$150,000 Cost of Sales and Marketing \$50,000		Revenues Streams Ventilators range in size and cost between \$25,000 to \$50,000 or more. They are used in intensive care units. With this epidemic the main idea is to help our countries so it will be in the range of \$4,000 to \$6,000		

Our Business Canvas is as the graph shows

Key Financial Projection

Key financial projections		
Year	2020	2021
Manufacturing cost	2,000	1,900
Selling price to distributor	3,500	3,500
Market price	4,500	4,500
Projected units to be sold	200	350
Revenue	700,000	1,225,000
Cost of material	400,000	665,000
Cost of R&D and testing	150,000	150,000
Cost of salaries	50,000	80,000
Cost of Company	5,000	5,000
Cost of sales	50,000	50,000
Net profit	45,000	275,000

Our financial projection for cost and sales for years 2020 and 2021

Machine Video And Photos

Videos: [Click Here](#)

Photos: [Click Here](#)

Team

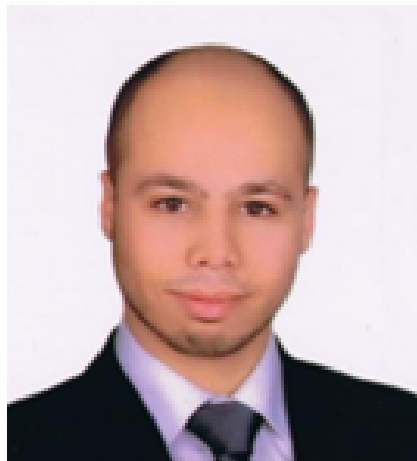

Mostafa Khalaf

CEO and cofounder

11 years in manufacturing, helping in building factories and operating them, currently working with PwC in the Real Estate department

MBA, BSC in Mechatronics Engineering

Took part in operating factories in Egypt, Italy, Jordan and Saudi Arabia

Anas Sabha

Technical Lead and cofounder

9 years in technical roles, including medical field experience, Currently the owner of Smarty plug start-up in Jordan, and ready to go to market product

BSC in Mechatronics Engineering

Lead Engineer in medicines factory, good understanding of troubleshooting, high programming skills for microcontrollers

Ziad Abu Ayyash

Medical Lead and cofounder

8 years in medical field, served in aftersales for ventilators agency in Jordan. Ziad owns a start up in medical field in Jordan named Sannula

BSc in Nursing

Passion for innovation drove Ziad to mix knowledge in nursing with love of engineering to continue work

on the first invention: the sannula

Machine Development

Our plan is to have this machine as the core machine to keep developing until we arrive a full scale Ventilator made in the Arab World